295W BEAM MOVING HEAD LIGHT

USER MANUAL

(TFT DISPLAY & TOUCH)



Please read over this manual before operating the light

CONTENTS

Chapter 1	Installation and attention	3
1.1	Maintenance	3
1.2	Statement	3
1.3	Safety Precaution	3
1.4	Product Instruction	3
1.5	Cable connection (DMX)	4
1.6	Rigging (Optional)	4
Chapter 2	Panel operation	6
2.1	Brief	6
2.2	Operation	6
2.2.1	Operate light with touch or KEY	6
2.2.2	Parameter value setting	6
2.2.3	Boolean parameter setting	7
2.2.4	Sub Menu (Parameter)	7
2.3	Operation and parameter instruction	7
2.3.1	ADDR--> Address: Set DMX Address	8
2.3.2	MODE--> WorkMode: Set Light work mode	8
2.3.3	DISP-->DISPLAY: Set display	9
2.3.4	TEST--> TestMode	9
2.3.5	ADVA-->Advanced: Set light run parameter	10
2.3.6	STAT-->Status: View status	11
Chapter 3	Channel description	12
3.1	Channel table	12

Chapter 1 Installation and attention

1.1 Maintenance

- To reduce the risk of electrical shock or fire, do not expose this unit to rain or moisture.
- Intermittently using will extend this item's service life.
- Please clear the fan, fan net , and optical lens in order to keep good work state.
- Do not use the alcohol or any other organic solvent to wipe the shell.

1.2 Statement

The product has perfect performance and integrity packing. All users should be strictly complying with the warning and operating instructions as stated. Or we aren't in charge of any result by misuse. Any damage resulting by misuse is not within the Company's warranty. Any fault or problem caused by neglecting the manual is also not in the charge of dealers.

Note: All information is subject to change without prior notice.

1.3 Safety Precaution

- In order to guarantee the product's life, please don't put it in the damp places or even the environment over 60 degree.
- Always mount this unit in safe and stable matter.
- Install or dismantle should be operated by professional engineer.
- Using lamp , the change rate of power voltage should be within $\pm 10\%$. If the voltage is too high, it will shorten the light's life; if it's not enough, will influence the effect.
- Please restart it 20 minutes later after turning off the light, until full-cooling. Frequent switching will reduce the life span of lamps and bulbs; intermittent using will improve the life of bulbs and lights.
- In order to make sure the product is used correctly, please read the Manual carefully.

1.4 Product Instruction

- Lamp: NEOLUX 14R 295W
- Channel mode: 18 DMX512 Channel
- Pan scan: 540°(16bit) Electric correction
- Tilt scan: 270° (16bit) Electric correction
- Amazing dot matrix, four tact switch, 180° turning show
- Color wheel: 14colors + white, and seven color effect;
- Gobo wheel: 14 gobos(8 fixed gobos + 5 glass gobos + white);
- Effect Wheel: 6 independent prisms,8 prism/T prism/6+12 prism/16 prism/T prism/8+16+24prism,Can combine 17 kinds of prism effects;
- 0-100% mechanical dimming, mechanical dimming and free dimming available.
- Strobe macro control available;

- Lens optical system chemical force , beam angle 0~4°;
- Over-heat protection
- Power Input: 100-240V, 50/60Hz
- Power Dissipation: 400W
- IP level :IP20
- Magnetic ballast and AC/Dc power supply
- Product Size: 523×337×511mm
- Packing Size: 635X440X725
- Net weight: 19.5KG

1.5 Cable connection (DMX)

Use a cable conforming to specifications EIA RS-485: 2-pole twisted, shielded, 120Ohm characteristic impedance, 22-24 AWG, low capacity. Do not use microphone cable or other cable with characteristics differing from those specified. The end connections must be made using XLR type 3 or 5-pin male/female connectors. A terminating plug must be inserted into the last projector with a resistance of 120Ohm (minimum 1/4 W) between terminals 2 and 3.

IMPORTANT: The wires must not make contact with each other or with the metal casing of the connectors. The casing itself must be connected to the shield braid and to pin 1 of the connectors.

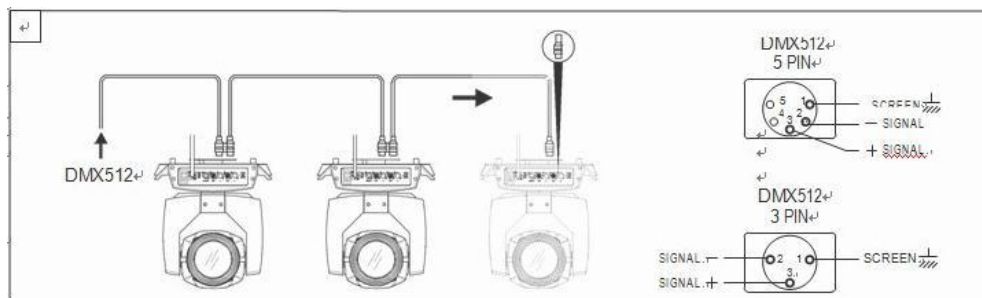

Figure 1 DMX Cable connection

1.6 Rigging (Optional)

This equipment can be positioned and fixed by clamp in every direction of the stage. Locking system makes it easy to fasten to the bracket.

Attention! Two clamps are needed to fix the equipment. Every clamp is locked by fastener of 1/4 kind. Fastener can only be locked clockwise.

Attention! Fasten a safety string to the additional hole of side aluminum piece. The secondary accessory could not hang on the delivery handle. Nip the equipment on bracket.

- Check if rigging clamp (not including the one inside) damaged or not? If stand ten times weight as the equipment. Make sure the architecture can stand ten times weight as all the equipment, clamps, wirings and other additional fixtures.
- Screws for clamping must be fixed firmly. Take one M12 screw (Grade 8.8 or higher) to clamp bracket, and then screw the nuts.

-
- Level the two hanging points at the bottom of clamp. Insert fastener to the bottom, lock the two levers by 1/4 rotating clockwise; then install another clamp.
 - Install on safety string which stands at least ten times weight as equipment. Terminal of the accessory is designed for clamps.
 - Make sure pan/tilt lock unlocked or not. Keep the distance more than 1M from equipment to flammable material or lighting source.

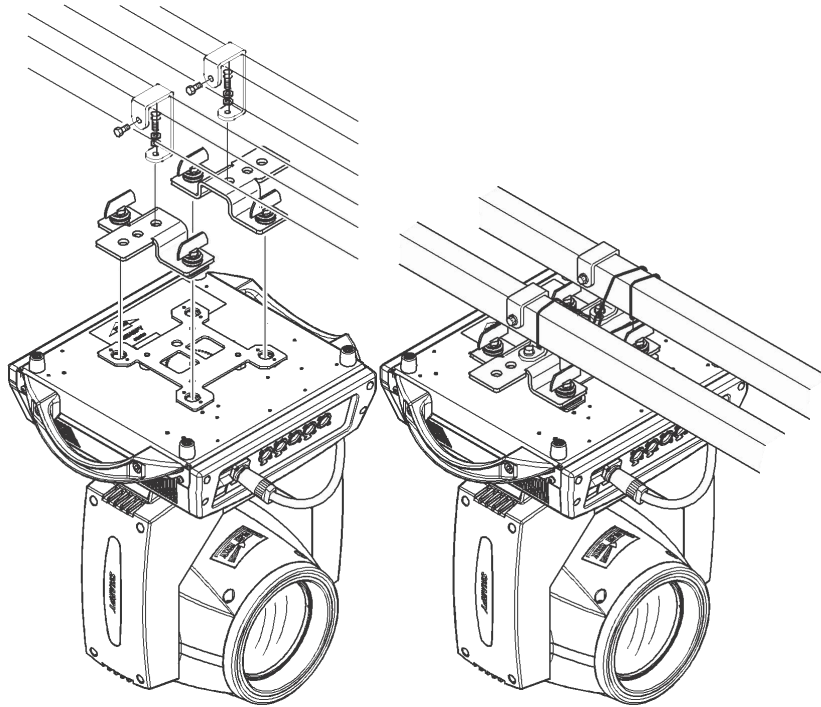

Figure 2 Installation

Chapter 2 Panel operation

2.1 Brief

The light panel diagram show as Figure 3, Left area is TFT Displayer, support touch, and right area is KEY, both of touch and KEY can operate light and setting.

Display & operation just like “Android operation system”, touch the item will set or modify setting.

Note: Prevent damage the touch or TFT displayer, do not use sharp objects chick displayer.



Figure 3 Panel diagram

2.2 Operation

2.2.1 Operate light with touch or KEY

- The left area is TFT Displayer and touch, chick item or value with finger will to complete operation of set light setting (parameters) or view light state.
- The area on the right hand side is 4 KEY. As auxiliary input interface, if disable touch function,, the KEY can been choose to set the parameter.

2.2.2 Parameter value setting

When the selected item is value need to been modified, the dialog shown in Figure 4 will popup.

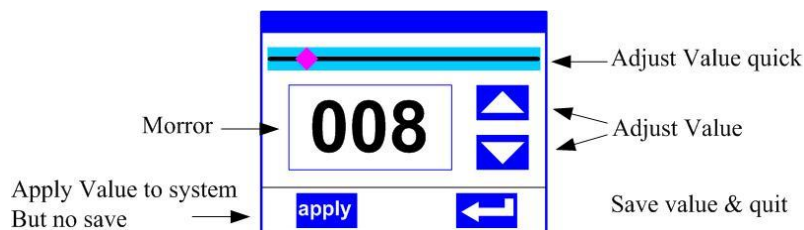

Figure 4 Dialog of value setting

- **Modify value:** Can quickly modify value via pull the slider to the desired position, or click the button of ‘up’ or ‘down’ whit finger on the right side to set the exact desired value, another way is roll encoder on the right hand side of panel.
- **Apply value:** When Value had been modified, Then press the bottom of ‘apply’ in the left corner to apply to the light, but haven’t saved;
- **Save Value:** Any time, click on the lower right corner of the "OK" button, the setting will be saved into internal memory.

2.2.3 Boolean parameter setting

- When the selected parameters is a Boolean value (such as ON or OFF), can directly modify setting by chick corresponding item, the setting will been saved right now.
- When the parameter is a key item, chick corresponding item, a dialog shown in Figure 5 will been popup ask for the confirm. Chick ‘sure’ to confirm.

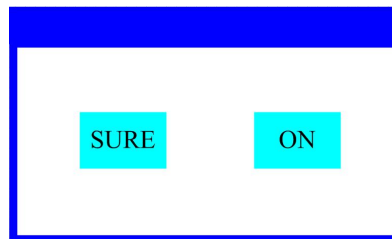

Figure 5 Dialog of confirm

2.2.4 Sub Menu (Parameter)

Chick item of main menu, enter corresponding sub menu, shown in Figure 6, total 6 sub menu, includes class of parameter and status:

- ADDRESS: Set light DMX address.
- WORKMOD: Set light work mode, master or slave mode when in auto run mode.
- DISPLAY: Set display parameter, e.g. selecting language.
- TEST: Used for test light, modify DMX channel data to test function, the corresponding function of reference channel function table.
- ADVANCE: Set light running parameter.
- STATUS: View light current status.



Figure 6 Parameter menu

2.3 Operation and parameter instruction

Via following operation, enter sub menu (parameter menu) shown in Figure 6

- In main menu, chick 1/6 function button into corresponding parameter menu.
- In sub menu (page), chick main item on the left side of displayer, can shift to corresponding sub menu(page) quickly.

2.3.1 ADDR--> Address: Set DMX Address

Click and select the "ADDR", can enter the page of DMX address setting, range from 1 to 512, the address code shouldn't is not greater than (512- channels quantity), otherwise the light will not be controlled. Following is the operation:

Enter the page of DMX address, as shown in Figure 7, click the blank area in right side of display will pop-up dialog as in Fig.4, modify value, then click 'ENTER' to confirm and save DMX address code.

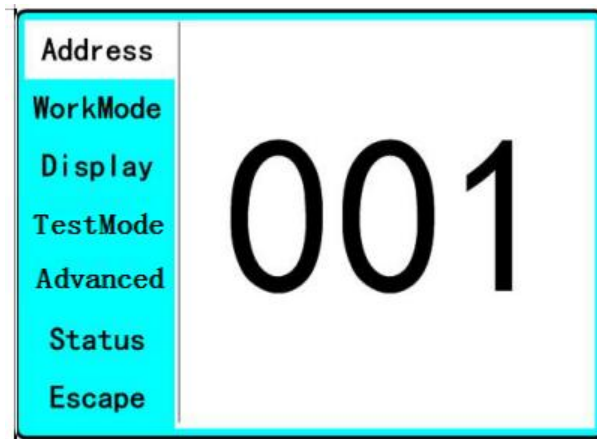

Figure 7 page of DMX Address

2.3.2 MODE--> WorkMode: Set Light work mode

Enter the page of 'WorkMode' as shown in Figure 8 and modify setting. Can set light work mode, control lamp and DMX channel mode.

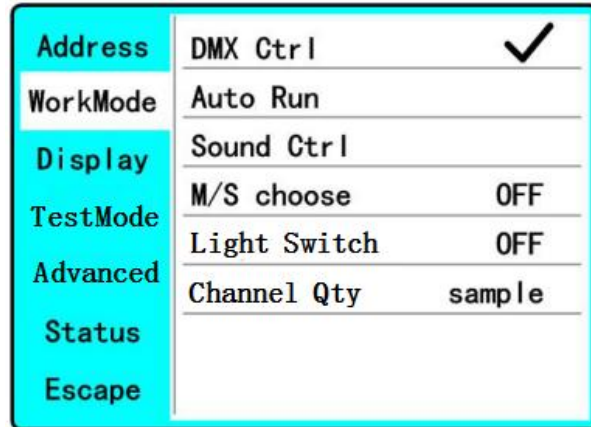

Figure 8 page of work mode

- ◆ **DMX Ctrl:** Choose to set DMX Mode,
- ◆ **Auto Run:** Choose to set Auto Mode,
- ◆ **Sound Ctrl:** Choose to set Sound Mode,
- ◆ **M/S Choose:** Available just in 'AUTO RUN' or 'SOUND Ctrl' mode.
ON--> Master. (Data will be sent to other slave lamp immediately.)
OFF--> Slaver. (NOT send data to other lamp via DMX Cable).(Default)
- ◆ **Light Switch:**
ON--> Turn on the light,
OFF--> Turn off the light.
- ◆ **Channel Qty:** Light support 2 DMX Channel mode: sample or extend.
Simple --> 18CH.(Default)
Expand--> 20CH(or null).

2.3.3 DISP-->DISPLAY: Set display

Light support 2 language, rotation display. Enter page as shown in Figure9 to set parameter following:

Address	Language	English
WorkMode	Screen saver	Mode3
Display	Screen rotation	OFF
TestMode	Touch Enable	ON
Advanced	Touch Rectify	
Status		
Escape		

Figure9 page of display

- ◆ **Language:** English / Chinese.
- ◆ **Screen Saver:** When panel is idle(these is no operation in 10 second), display will enter saver status.
 - OFF--> No screen saver.
 - Mode1--> Power-saving mode, turn off the display.
 - Mode2--> Displays the current address.
 - Mode3--> Displays the icon and the current working mode.(Default)
- ◆ **Screen Rotion:** To turning display.
 - ON--> Normal display.(Default)
 - OFF--> 180° turning display.
- ◆ **Touch enable:** Disable or enable touch function,.
 - ON--> Enable touch function.(Default)
 - OFF--> Dosable touch function.
- ◆ **Touch adjust:** Adjust touch function. Normally, not enter this item.

2.3.4 TEST--> TestMode

Enter the page as shown in Figure 10, Light will into test mode, in this mode, the light does not receive the data for DMX controller.:

Address	PAN	000
WorkMode	TILT	000
Display	FOCUS	000
TestMode	COLOR	000
Advanced	GOBO	000
Status	PRISM	000
Escape	FROST	000
	STROBE	000

- ◆ **PAN:** range for 0 to 255;
- ◆ **TILT:** range for 0 to 255;
- ◆ **FOCUS:** range for 0 to 255;
- ◆ **COLOR:** range for 0 to 255;
- ◆ **GOBO:** range for 0 to 255;
- ◆ **PRISM:** range for 0 to 255;
- ◆ **FROST:** range for 0 to 255;;
- ◆ **STROBE:** range for 0 to 255;

2.3.5 ADVA-->Advanced: Set light run parameter

Enter the page as shown in Figure 11, set the parameter of light:

Address	PAN Inset	OFF
WorkMode	TILT Inset	OFF
Display	P/T Rectify	ON
TestMode	PAN Offset	010
	TILT Offset	010
Advanced	Lamp when	Power ON
Status	Data hold	OFF
Escape	Factory Setting	

Figure 11 page of run parameter

- ◆ **Pan Invert:** Reverse PAN move
OFF--> Pan Normal move.(Default)
ON--> Reverse PAN move.
- ◆ **Tilt Invert:** Reverse TILT move
OFF--> Tilt Normal move.(Default)
ON--> Reverse Tilt move.
- ◆ **P/T Rectify:** Disable or enable position rectify function.
OFF--> Disable P/T rectify
ON--> Enable P/T rectify-(Default)
- ◆ **Pan Offset:** Set PAN original position. **Default: 10**
- ◆ **Tilt Offset:** Set TILT original position. **Default: 10**
- ◆ **Lamp when:**
PowerON--> Turn on the lamp when power on.(Default)
RstDone--> Turn on the lamp after reset.
Manual--> Manually turn on the lamp.
- ◆ **Data hold:**
OFF--> When no DMX signal, return to middle position.(Default)
ON--> When no DMX signal, stop in the final position.
- ◆ **Factory Setting:** Restore all parameter to factory setting.

2.3.6 STAT-->Status: View status

Enter the page as shown in Figure 12:

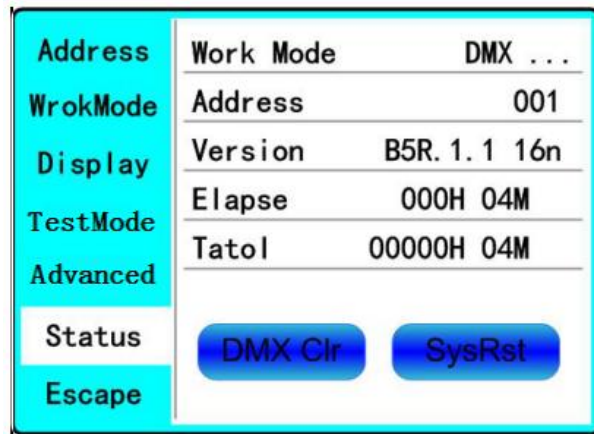
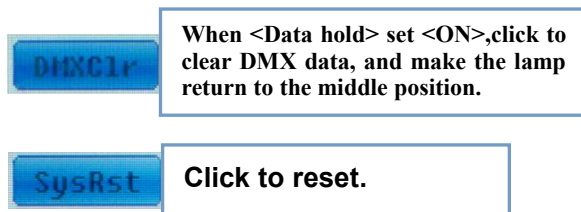

Figure 12 page of status

- ◆ **Work Mode:** Show the current working mode.
- ◆ **Address:** Show the current address.
- ◆ **Version:** Show the version of the light.
- ◆ **Elapse:** Working hours after turning on.
- ◆ **Totol:** Cumulative hours of operation



Chapter 3 Channel description

3.1 Channel table

Table 1 Channel brief

CH1	PAN	0-255	0-540°
CH2	PAN 16bit	0-255	
CH3	TILT	0-255	0-270°
CH4	TILT 16bit	0-255	
CH5	XY Speed	0-255	Fast to slow
CH6	Dimmer	0-255	0-100%
CH7	Strobe	0-3	Dark
		4-103	Slow strobe to fast strobe
		104-107	White
		108-207	Slow strobe to fast strobe(mode 2)
		208-212	White
		213-251	Free strobe
		252-255	White
CH8	Frost	0-127	
		128-255	Insert frost
CH9	Color	0-4	White
		5-9	White + COLOR1
		10-14	COLOR1
		15-19	COLOR1 + COLOR2
		20-24	COLOR2
		25-29	COLOR2 + COLOR3
		30-34	COLOR3
		35-39	COLOR3 + COLOR4
		40-44	COLOR4
		45-49	COLOR4 + COLOR5
		50-54	COLOR5
		55-59	COLOR5 + COLOR6
		60-64	COLOR6
		65-69	COLOR6 + COLOR7
		70-74	COLOR7
		75-79	COLOR7 + COLOR8
		80-84	COLOR8
85-89	COLOR8 + COLOR9		
90-94	COLOR9		
95-99	COLOR9 + COLOR10		
100-104	COLOR10		

		105-109	COLOR10 + COLOR11
		110-114	COLOR11
		115-119	COLOR11 + COLOR12
		120-124	COLOR12
		125-129	COLOR12 + COLOR13
		130-134	COLOR13
		135-139	COLOR13 + WHITE
		140-144	COLOR14
		145-149	COLOR14 + WHITE
		150-200	Rotate forward (fast to slow)
		201-255	Rotate reverse (slow to fast)
CH10	Gobo	0-4	White
		5-9	GOB01
		10-14	GOB02
		15-19	GOB03
		20-24	GOB04
		25-29	GOB05
		30-34	GOB06
		35-39	GOB07
		40-44	GOB08
		45-49	GOB09
		50-54	GOB010
		55-59	GOB011
		60-64	GOB012
		65-69	GOB013
		70-128	Rotate forward (fast to slow)
		129-131	Stop
		132-190	Rotate reverse (slow to fast)
		191-195	Shake slow to fast GOB01
		196-200	Shake slow to fast GOB02
		201-205	Shake slow to fast GOB03
		206-210	Shake slow to fast GOB04
		211-215	Shake slow to fast GOB05
		216-220	Shake slow to fast GOB06
		221-225	Shake slow to fast GOB07
		226-230	Shake slow to fast GOB08
231-235	Shake slow to fast GOB09		
236-240	Shake slow to fast GOB010		
241-245	Shake slow to fast GOB011		
246-250	Shake slow to fast GOB012		
251-255	Shake slow to fast GOB013		
CH11	7 Colorful	0-127	None

		128-255	Insert 7 colorful
CH12	Prism1	0-127	None
		128-255	Prism1
CH13	Prism1 Rot	0-127	0-400 degrees
		128-187	Rotate forward (fast to slow)
		188-195	Stop
		196-255	Rotate reverse (slow to fast)
CH14	Prism2	0-127	None
		128-255	Prism2
CH15	Prism2 Rot	0-127	0-400 degrees
		128-187	Rotate forward (fast to slow)
		188-195	Stop
		196-255	Rotate reverse (slow to fast)
CH16	Focus	0-255	From far to near
CH17	Lamp	100-105	Close lamp over 3 seconds
		200-205	Open lamp over 3 seconds
CH18	Reset	210-215	Reset over 3 seconds
		220-235	Close lamp over 3 seconds
		240-255	Open lamp over 3 seconds
